

# DRYWALL MITTERED FRAMES

DIMENSIONS IN  
( ) ARE METRIC

TOP TO TOP  
4 1/2" HINGES ONLY  
1 3/4" DOOR

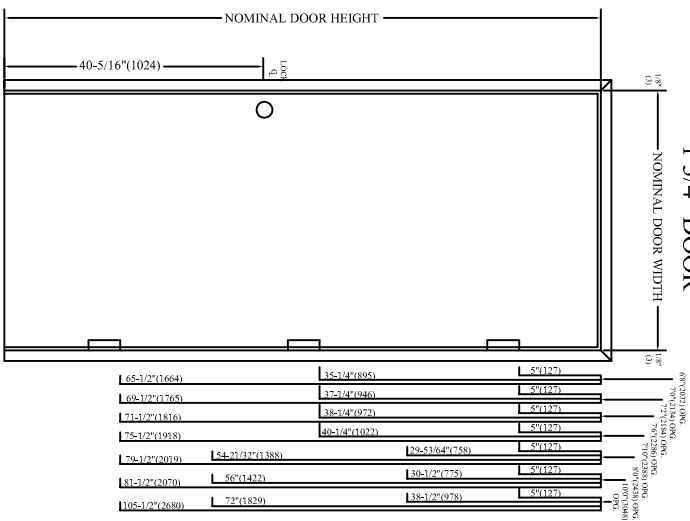

ELEVATION  
For 1-3/4" (44) Single Door

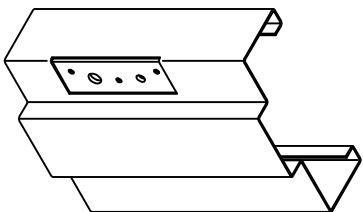

9 GA. HINGE  
REINFORCEMENT WITH  
4-1/2" (114) X 4-1/2" (114)  
FULL MORTISE HINGE  
PROVISION

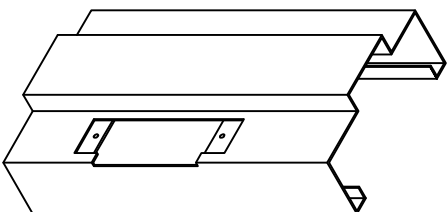

14 GA. STRIKE  
REINFORCEMENT WITH  
ANSI A115.1 OR ANSI  
A115.2 UNIVERSAL  
STRIKE PROVISION

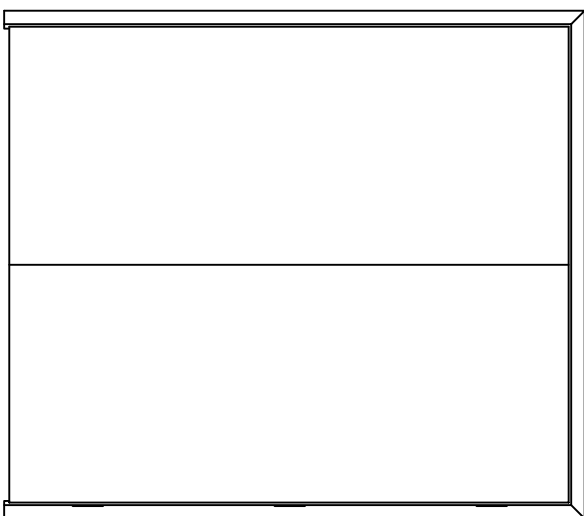

ELEVATION  
For 1-3/4" (44) Double Doors

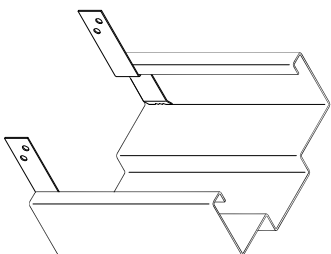

SNAP-IN SILL  
ANCHORS

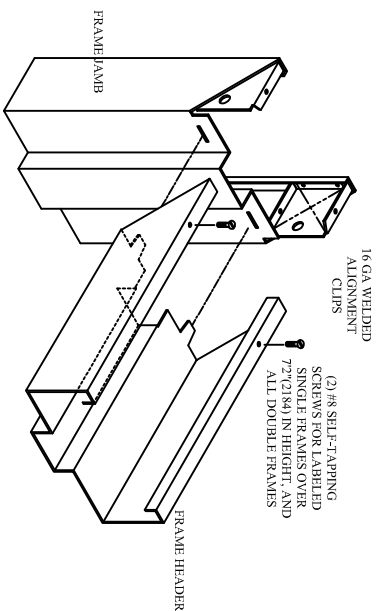

16 GA WELDED  
ALIGNMENT  
CLIPS  
(2) #8 SHL-F-TAPPING  
SCREWS FOR LABELED  
SINGLE FRAMES OVER  
77\"/>

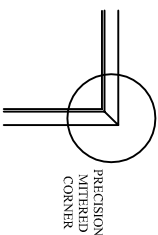

PRECISION  
MITTERED  
CORNER